

PRO Series Generator

Installation Operation Manual
thermasol.com/solutions

PRO-84, PRO-140, PRO-240, PRO-395, PRO-500, PRO-650, PRO-850

THERMASOL[®]

OVER 55 YEARS OF STEAM SHOWER INNOVATION

1 Important Information Before You Install

Make sure the walls, ceiling and floor materials are suitable for use with steam. If using acrylic walls, they must be steam rated from their manufacturer. ThermaSol only recommends specific generators for acrylic modules. Ensure electrical power is turned off for the duration of the installation.

PLEASE REVIEW WARNINGS BELOW AND LEAVE THIS MANUAL WITH HOMEOWNER

DO NOT USE THIS PRODUCT UNLESS YOU HAVE CONSULTED WITH YOUR DOCTOR AND RECEIVED WRITTEN PERMISSION TO DO SO. USE OF THIS PRODUCT MAY BE HAZARDOUS TO YOUR HEALTH.

PLEASE CONSULT YOUR PHYSICIAN BEFORE USING. IF YOU ARE PREGNANT, ELDERLY, HAVE HIGH BLOOD PRESSURE, DIABETES, SUFFER FROM HEART DISEASE, AND INTOXICATED, OR NOT IN GOOD HEALTH, DO NOT USE THIS STEAM BATH.

STEAM IS HOT! DO NOT TOUCH OR GO NEAR THE STEAMHEAD FROM THE TIME THE UNIT IS "ON", UP TO ONE HOUR AFTER IT HAS SHUT OFF. SEVERE BURNS WILL OCCUR IF YOU COME IN CONTACT WITH THE STEAMHEAD OR STEAM EMITTING FROM THE STEAMHEAD.

NEVER ATTEMPT TO FILL AROMA RESERVOIR ON THE STEAMHEAD WHEN UNIT IS IN THE ON POSITION. SEVERE BURNS WILL OCCUR.

DO NOT USE THERMASOL AROMATHERAPY OILS OR SKIN CARE PRODUCTS OR ANY PRODUCT ASSOCIATED WITH YOUR THERMASOL UNIT WITHOUT CONSULTING WITH YOUR ALLERGIST OR DOCTOR BEFORE USE. THESE PRODUCTS MAY BE HAZARDOUS TO YOUR HEALTH.

DO NOT USE STEAM ROOM WHILE UNDER THE INFLUENCE OF ALCOHOL OR DRUGS, AS THIS CAN BE HAZARDOUS TO YOUR HEALTH.

YOUR SHOWER MAY BE A SLIP-AND-FALL HAZARD. CHECK WITH YOUR CONTRACTOR OR FLOORING MANUFACTURER REGARDING THE SAFE USE OF YOUR FLOORING IN A STEAM APPLICATION. SLIPPING AND FALLING INTO THE STEAMHEAD ITSELF OR INTO THE STREAM EMITTING FROM THE STEAMHEAD WILL CAUSE SERIOUS BURNS OR PHYSICAL INJURY.

IF YOU ARE FEELING UNCOMFORTABLE, DIZZY, FAINT, OR STARTING TO FALL ASLEEP IMMEDIATELY EXIT THE STEAM ROOM.

DO NOT USE STEAM ROOM IF YOU ARE UNDER THE AGE OF 16 UNLESS SUPERVISED BY AN ADULT.

THERMASOL STEAM BATH GENERATORS ARE NOT DESIGNED TO BE USED FOR SPACE HEATING PURPOSES.

THERMASOL STEAM BATH GENERATORS ARE FOR INDOOR USE ONLY. THEY SHOULD NEVER BE LOCATED OUTSIDE THE HOME.

All products must be installed in accordance with installation instructions provided. Failure to do so may invalidate warranty at manufacturer's discretion.
©2016 ThermaSol.

2 Tools and Materials

Parts enclosed with the generator:

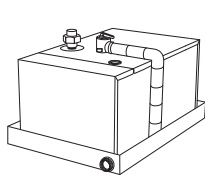

Steam generator

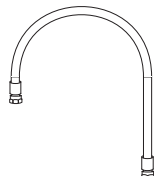

3/8" Hose & Fitting
(Items 02-8239 & 04-1810)

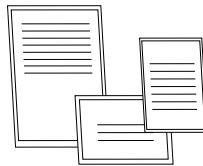

Installation instructions,
warranty, static cling
warning label



In-line water screen kit
(comes pre-installed from the
factory) Item 04-8457

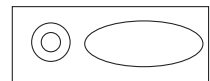

Steamhead Housing and
Cable Kit (10-8034-1)

Materials needed:

- Brass ball valve 3/8" NPT or brass shut-off valve (for water supply shut-off)
- Pipe compound
- Copper or brass fittings & nipples (sizes and quantities per instructions)
- Wire (see page 3)
- Copper tube or pipe
- Wire cap nuts
- Flex conduit (for units 12kW and above)

- Brass or copper tee connection and plug
- Silicone
- Other materials as required

Materials recommended:

- In-line water filter (recommended)
- PRO-650 and PRO-850: (2) 1/2" - 3/4" drop elbow/adapters

Tools needed:

- Pipe wrench
- Tubing cutter

- Wire cutters or wire strippers
- Adjustable wrench
- Screwdriver (Phillips and regular)
- Solder and flux
- 1-1/16" inch masonry drill bit
- 2-1/2" inch hole saw for ThermaSol NoTouch steamhead rough-in
- Drill motor
- Propane torch
- Other tools as required

Read warnings on page 2. For illustrative purposes only. Consult with qualified professional for steam room construction details.

3 Sizing or Double Checking the Unit Specified

If you are installing the unit or thinking of adding one on your next project, you will need to make sure the unit is sized properly.

Calculate the shower area
(Length x Width x Height = Cubic Feet)
 and confirm the ceiling height does not exceed 8 feet. The set of numbers in the generator model number represents the maximum capacity.

Example: Generator model PRO-240 will be sufficient up to 240 cubic feet (with a ceiling not exceeding 8 feet in height). Up-size 1 Unit size for every foot over 8 foot to a maximum of 10 foot.

Model number can be found on the box or generator.

ThermaSol's generators can be placed up to 50 feet from the shower; in an attic, closet or below a sink are ideal locations. Make sure the walls, ceiling and floor materials are suitable for use with steam.

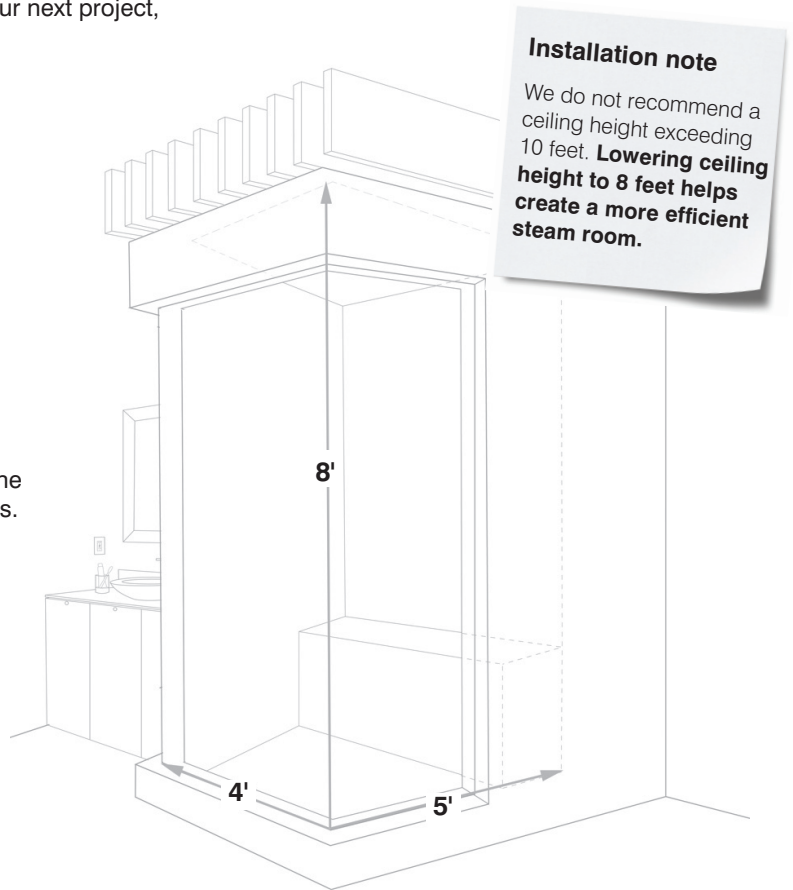

4 Electrical Wiring

The size of the shower will determine the size of the generator. The size of the generator will determine electrical requirements.

- All the electrical wiring must be done per National/Local Electrical Codes.
- Run 240V Power source to the generator.
- Use copper wire only.
- Wire sizes recommended by NEC (2002 Version). Minimum wire temperature rating 90°C. Type THHN.
- Each generator should be wired to their own separate breaker
- Turn off all electricity to the working area at the main breaker panel!
- Leave power OFF during installation process.

MODEL	INPUT VOLTAGE	KW RATING	AMPS	PHASE	WIRE	BREAKER	ELECTRICAL	MAX. ROOM SIZE
PRO-84	208-240VAC	6.0	28	1	10	30	NEMA 6-30P	84 CU.FT.
PRO-140	208-240VAC	8.0	37	1	8	40	NEMA 6-50P	140 CU.FT.
PRO-240	208-240VAC	10	46	1	8	50	NEMA 6-50P	240 CU.FT.
PRO-395	208-240VAC	12	55	1	6	60	Hardwire	395 CU.FT.
PRO-500	208-240VAC	15	69	1	4	90	Hardwire	500 CU.FT.
PRO-650	208-240VAC	20	92	1	0	100	Hardwire	650 CU.FT.
PRO-850	208-240VAC	24	110	1	0	120	Hardwire	850 CU.FT.

ThermaSol requires that a licensed electrician perform all electrical work.

Read warnings on page 2. For illustrative purposes only. Consult with qualified professional for steam room construction details.

5 Placing the Generator

Select a location as near as practical to the steam shower. Typical locations include: closet, vanity cabinet, climate controlled attic or basement.

Be sure to install unit in a location that offers easy accessibility for servicing of generator.

DO NOT install generator inside steam room.

DO NOT install generator or plumbing lines in unheated attic or any locations where water could freeze.

DO NOT install generator outdoors or wherever environmental conditions may affect the safety and/or performance of the generator.

Generator may be installed up to 50 feet away from steam shower and must be in a dry, non-combustible, well ventilated space with 6" clearance around generator.

When constructing the ceiling add slope of 1"/foot. The control cable provided with the generator is 50 feet in length (Item 03-6152-050).

When locating the control unit, place it as far as possible away from the steam head and as close as is practical to where the user will be sitting.

Optional 100-foot cable (Item 03-6152-100) and 20 foot cable (Item 03-6152-020) are available for purchase.

The generator must be upright, accessible and on a level surface with all connections on top. Access panel must be unobstructed and allow for easy access.

Example of different generator locations.

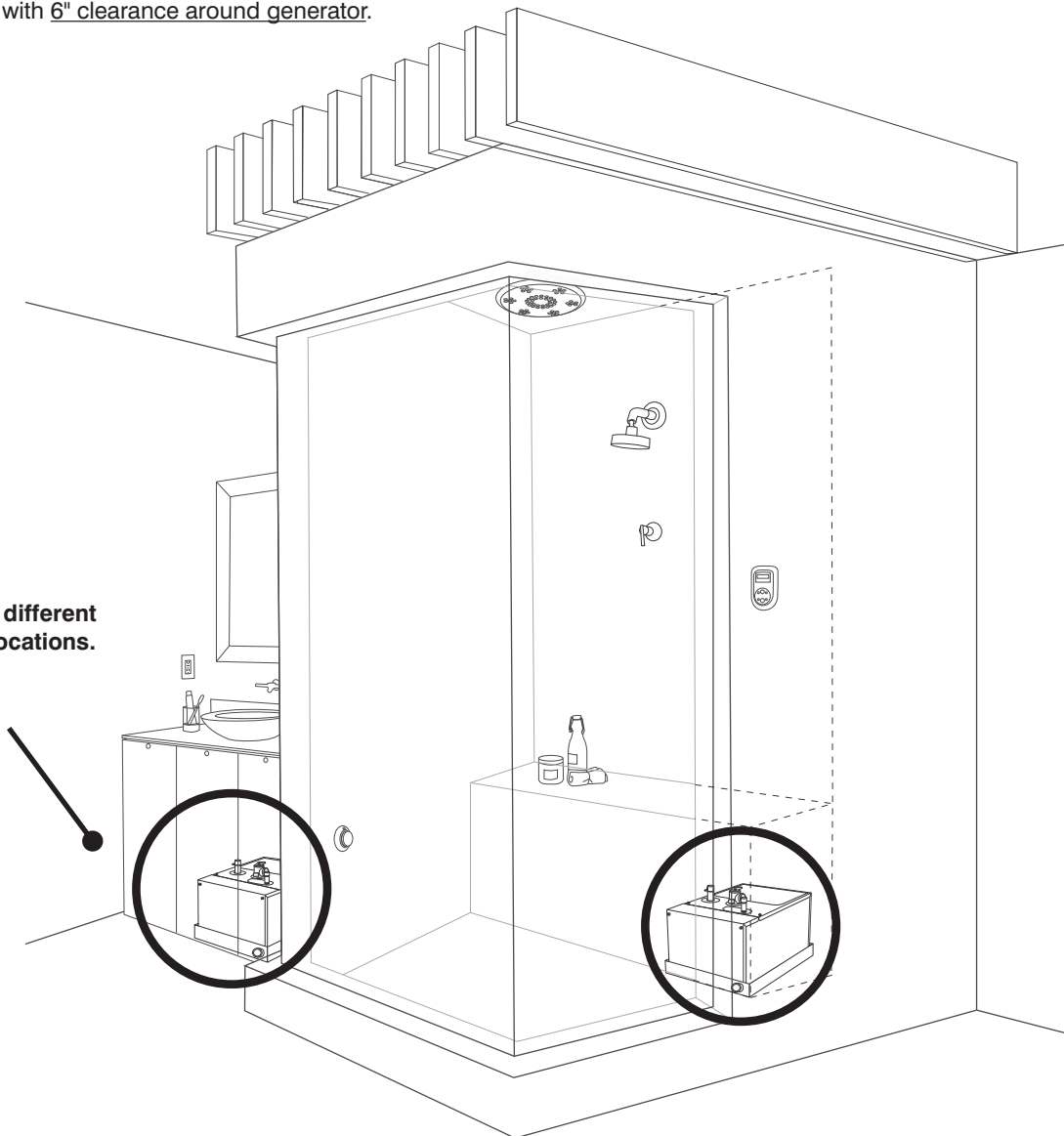

6 Water Supply and Drain Pan

Once you select the generator location, you will need to run water to the unit.

DO NOT use galvanized fittings. Use copper or brass fittings only!

DO NOT use PEX or PVC tubing.

DO NOT plumb the pressure relief valve into the steam line. Plumbing the pressure relief valve into the steam line can be hazardous, should the steam outlet be capped off or obstructed.

Recommend installing unions on all rigid pipe lines for ease of removal and serviceability (if required).

- A** Use 3/8" NPT line to connect to supplied 3/8" braided hose.
- B** Pre-Installed drain pan under the unit.
- C** Plumb the 3/4" drain connection on pan to an approved drain. Drain Pan must be installed on all generator installations.

- D** Connect a tee to the existing cold water line. Install copper pipe from the tee to create inlet line for unit.
- E** Install a brass shut off valve on the water inlet line in an accessible area in front of the brass union (and recommended in-line water filter). A stainless steel water supply flex connector may be used.
- F** Pre-Installed water line debris screen (included) in the water inlet on the generator.

Before making the water connection, flush the water line into a five-gallon pail to remove any silt or other materials that may be in the water inlet line.

Make final connection but DO NOT turn the water or power on yet.

All plumbing shall be performed by a qualified licensed plumber and in accordance with applicable national and local codes.

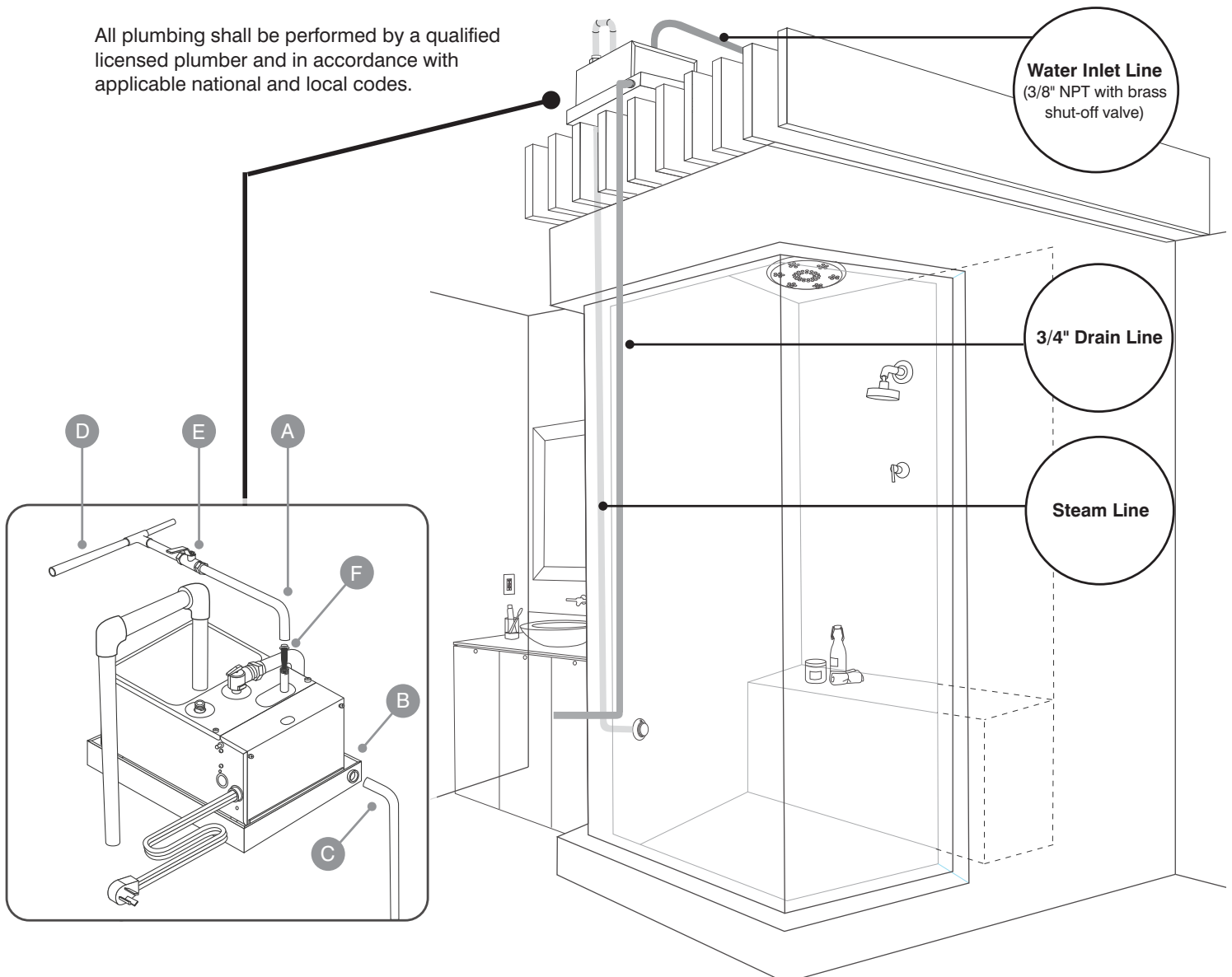

7 Steam Line and Steamhead

Now you will need to decide on the steamhead placement in the shower so you can run the steam line from the generator to the steamhead. There are a couple of things you need to know about the placement of the steamhead and steam line itself.

DO NOT install any valve in the steam line. Flow of steam must be unobstructed.

DO NOT plumb any traps in the steam line.

- A** The steam outlet on the generator requires a 1/2" brass union for easy installation (included).
- B** For PRO-650 and PRO-850 models use 3/4" brass pipe or copper tubing for the steam line..

The steam line can run up and then down, once; or horizontal; but never run down and then up. If it does, a steam trap will be produced at the low point blocking the flow of steam.

Insulate the steam outlet piping if the piping run exceeds 10 feet or is exposed to cold areas. Use steam rated insulation.

Pitch/angle steam lines back towards generator before any up or down turns; pitch/angle towards steam room after any up or down and avoid perfectly level plumbed lines.

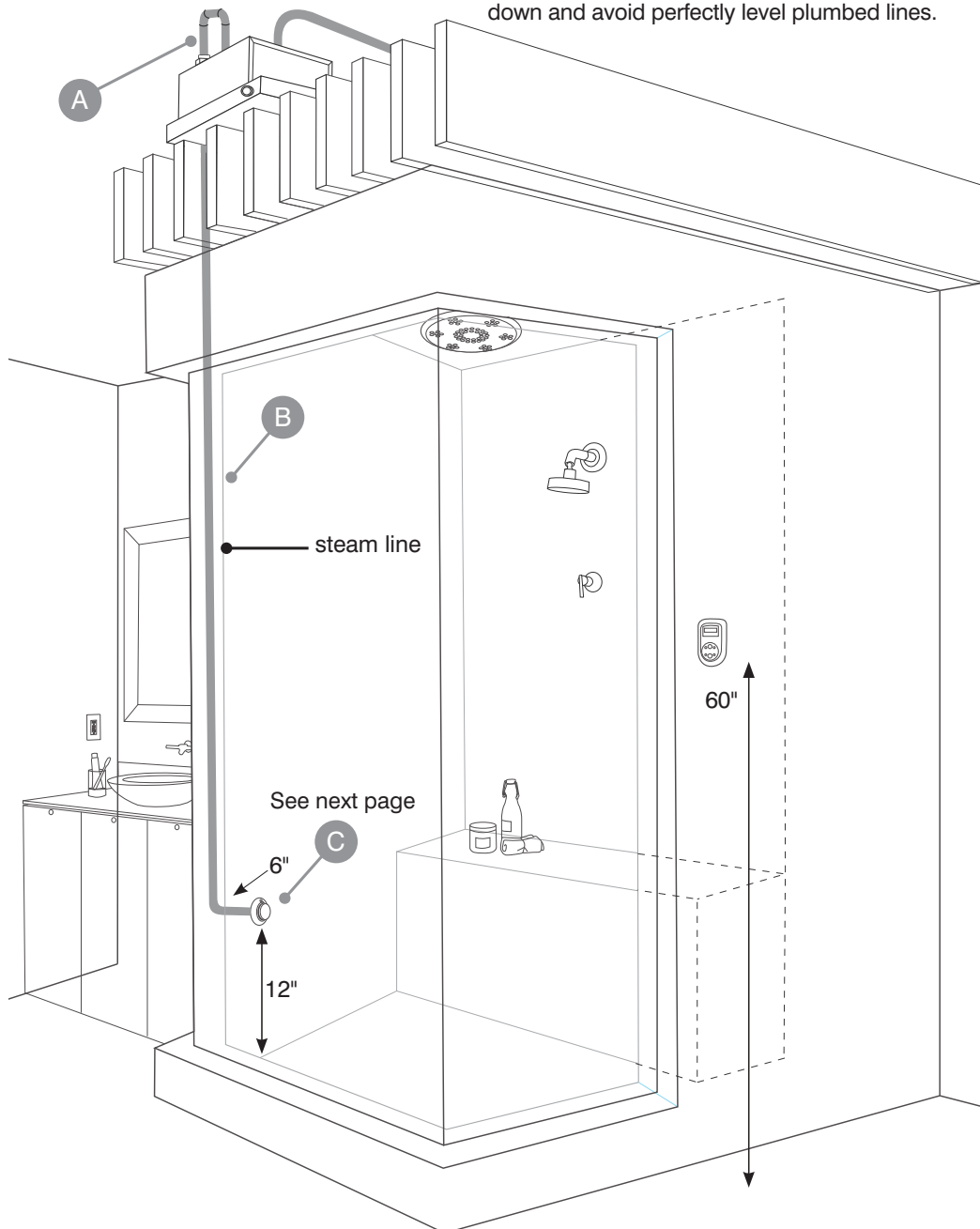

Read warnings on page 2. For illustrative purposes only. Consult with qualified professional for steam room construction details.

Steamhead Location

DO NOT install the steamhead near the seating area or the user.

DO NOT forget to install the steamhead rough-in fitting!

- C** Install the steamhead 12" from the floor or bathtub rim and 6" from any corner.

Steamhead is to be mounted as far as possible from typical bathing position (seated or standing) and installed as far from the in-shower controller as possible.

i. For retrofit to existing finish wall:

Drill a 2-1/2" diameter hole in the shower wall or wall above bathtub rim for the steam outlet rough-in fitting and install to be flush with the finished wall. (plumbing must be done from backside of finished space)

ii. For new framing: Mount and install rough-in fitting to be flush with finished wall +/- 1/8".

- D** Connect a 1/2" NPT brass pipe or copper tubing to the steam outlet union (not included) on the generator running the pipe to the steam head location in the wall to connect with the steamhead rough-in fitting. It is very important that the pipe is firmly secured to the wall, so that when the steamhead is installed it doesn't push the rough-in fitting back into the wall. Install a 1/2" drop-ear elbow on the end of the 1/2" pipe or tubing for the rough-in fitting. For all the connections, use solder for copper joints and Teflon tape for pipe fittings and do not over tighten fittings. **DO NOT USE PVC CEMENT.**

For detailed installation instructions of the steamhead please see Installation section in thermasol.com/customer-support

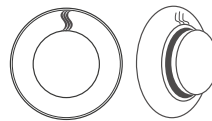

Upon final installation mount steamhead with  facing up to allow aromatherapy well to dispense steam.

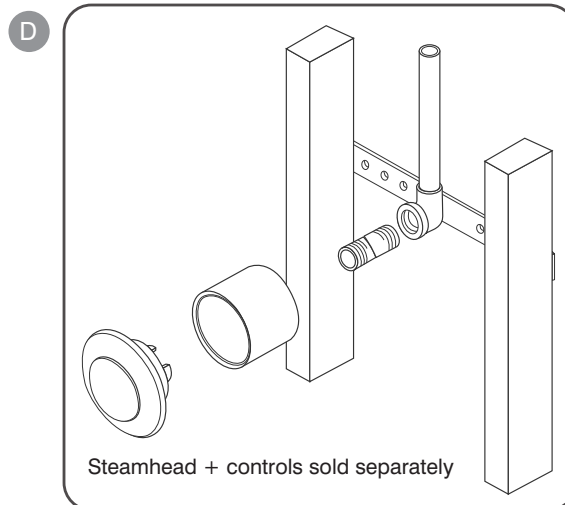
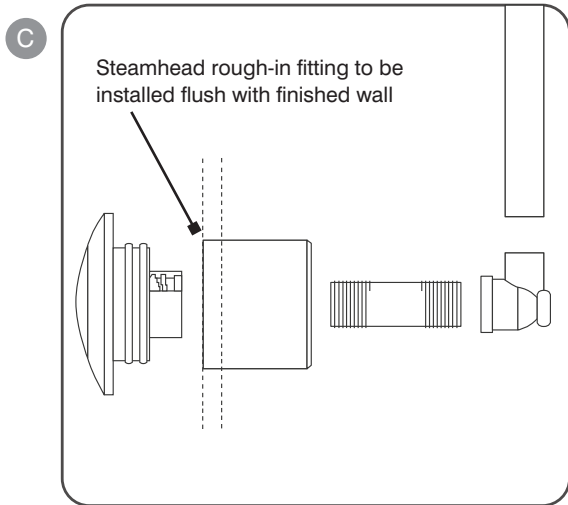

8 Final Pre-Check Before Operation

Turn ON the water supply to the generator. Check all the connections for leaks.

Plug in generator (unless hardwired model).

Turn ON the power source or breaker.

Verify control panel lights up and test operation. Note: Initial power-on phase takes several minutes for generator to heat up steam.

Please direct the home owner to visit www.thermasol.com/solution and click on the "I'm the home owner" button to learn about set-up and programming (in order to set up the clock and any other options if applicable).

Registration information on page 9.

ThermaSol Product Registration

Dear ThermaSol End User:

Please register your product at www.thermasol.com/warranty so we can assist you much quicker if you ever need to contact our Technical Support Department.

In addition we'll keep you informed about your product and time to time we'll update you about new products and other company announcements.

Thank you from all of us at ThermaSol and we wish you many relaxing and steamy days ahead.

We will not sell, rent or share your personal information.

You may also fill out the form on the back side of this page and mail it to:



1958 Steam Way
Round Rock, TX 78665



GENERATOR WARRANTY

All warranties provided by ThermaSol after September 1, 2014, shall extend only to the original retail purchaser or end user of the product and are contingent on the proper use of the product in accordance with the instructions and specifications published by ThermaSol and shall not apply to any product that has been repaired or modified by persons other than approved by ThermaSol. Proof of purchase from Authorized Reseller will be required to start any warranty process except where prohibited by law. These warranties are not valid for any product that is sold with defaced or altered serial number, or for any product that was purchased used, refurbished, "as is", or in unknown condition.

All warranty claims must go through ThermaSol directly.

GENERATORS

PRO Series, AF Series and SSM Series Generators manufactured from June 1, 2007 – current

No warranty of any kind, expressed or implied is provided for PRO Series, AF Series and SSM Series Generators installed or used in any non-residential setting.

"IN-HOME" LIMITED WARRANTY

ThermaSol extends to the original purchaser a 3-year limited "In-Home" warranty to repair or replace (at its discretion) PRO Series generator parts found to have manufacturing defects, and to provide the necessary labor. 2-year limited "In-Home" warranty to repair or replace (at its discretion) AF Series and SSM Series generator parts found to have manufacturing defects, and to provide the necessary labor. After the "In-Home" Limited Warranty expires, the Lifetime - Factory Limited Warranty applies.

LIFETIME - FACTORY LIMITED

Warranty ThermaSol will replace any defective parts for the life of the product and will cover the labor at the factory. The customer is responsible for the removal/installation and shipping and handling to and from our factory in Round Rock, TX. ThermaSol guarantees all parts to be free from manufacturing defects in material and workmanship under normal use when installed in a residence only.

EXCLUSIONS

These warranties will be terminated by ThermaSol for the following reasons:

- 1. Improper installation, such as installation that fails to observe National/ Local Plumbing and/or Electrical codes.
- 2. Use of a residential unit in a non-residential or commercial application, including a hotel.
- 3. Service to equipment by unauthorized personnel.
- 4. Installation that does not permit proper access for service.
- 5. Non-payment of repairs not covered under warranty.
- 6. Modification to any part of the unit.
- 7. Use of non-ThermaSol repair parts.
- 8. Alteration or removal of product serial number.

LIMITATIONS

- 1. ThermaSol will not be liable in any way for any indirect, special, incidental, exemplary, or consequential damages resulting from the sale, delivery, installation or use of its products. Users are responsible for suitability of the products for their application. Damage resulting from improper specification or application or other operating conditions beyond ThermaSol's control is not under warranty.
- 2. ThermaSol will not exercise reasonable efforts in rendering service under these warranties, but shall not be liable for any damage arising out of delays; these warranties only cover the repair and/or replacement of ThermaSol product as specified by the warranty.
- 3. ThermaSol does not guarantee that a local service person will be available for in-home services. Unit may have to be removed and reinstalled at owner's expense. It is the responsibility of the buyer to file a claim with the carrier/carriers for any product that has shipping damage to or from ThermaSol. An EVA (Evaluation Number) must be obtained from the factory and used on any correspondence or packages sent to the factory.
- 4. THESE WARRANTIES ARE NON-TRANSFERABLE TO ANY OTHER PURCHASER OR PARTY OTHER THAN THE ORIGINAL PURCHASER FROM AN AUTHORIZED DEALER. THESE WARRANTIES ARE NOT VALID FOR ANY PRODUCTS SOLD USED, REFURBISHED, "AS IS", OR IN UNKNOWN CONDITION. NO OTHER AGENT OR PARTY CAN GIVE ANY OTHER WARRANTY OR PROMISE. THESE ARE THE SOLE WARRANTIES FOR YOUR THERMASOL PRODUCT, EXCEPT AS PROVIDED BY LAW.

These warranties give you specific legal rights and you may also have other rights, which may vary, from state to state. Determination of rights under these warranties is in accordance with the laws of Texas. Any dispute under these warranties must be submitted and resolved by arbitration in Texas.

GENERATOR WARRANTY REGISTRATION CARD

HOMEOWNER'S NAME: _____ PHONE: (____) _____

ADDRESS: _____ CITY: _____ STATE: _____ ZIP: _____

EMAIL: _____

SERIAL NO. _____ DATE CODE: _____ MODEL NO: _____

DATE OF PURCHASE: _____ DEALER/OUTLET: _____

INSTALLER NAME: _____ INSTALLER PHONE: (____) _____

INSTALLER ADDRESS: _____ CITY: _____ STATE: _____ ZIP: _____

SIGNATURE: _____ DATE INSTALLED: _____

THERMASOL®

Superior Steamshower Systems

